

ARIA 91

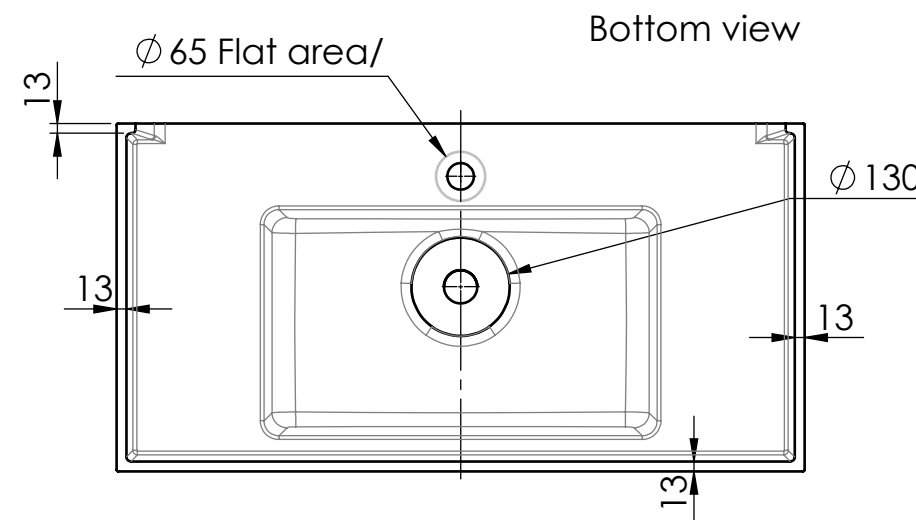
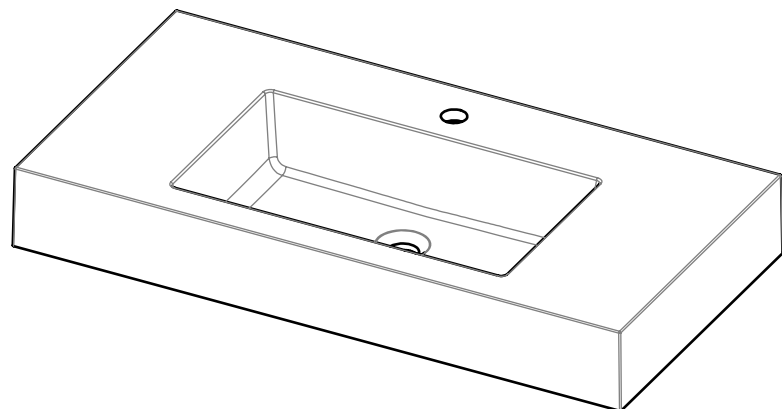

Tolerancia total	Largo	+3/0 mm
	Ancho	+2/0 mm
	Alto	+2/-2 mm
Tol. altura paredes laterales	≤25 mm	+1/-1 mm
	>25 mm	+2/-2 mm
Tolerancia ubicación de los agujeros		+2/-2 mm
Tolerancia diametro de los agujeros		+1/-1 mm
Tolerancia a la flexión del plano		+1,5/-1,5 mm